



Redroad

Brand Introduction

A comfortable and clean living space for you

CONTENT

01

Brand Introduction

03

Product Comparison

02

Product Introduction

04

Brand Promotion





01

Brand Introduction



About Redroad

Born in 2021, Redroad is a global smart home appliance brand focusing on the vacuum cleaner market. It has independent R&D, design, manufacturing, sales, and service departments.

Redroad positions itself as the provider of "a comfortable and clean living space". With a user-oriented mentality, visionary insights into the modern lifestyle, extraordinary design and R&D capacity, and pursuit of quality, RedRoad has never ceased to provide "artsy appliances" that are exquisite, sleek, quality build, and user-friendly.

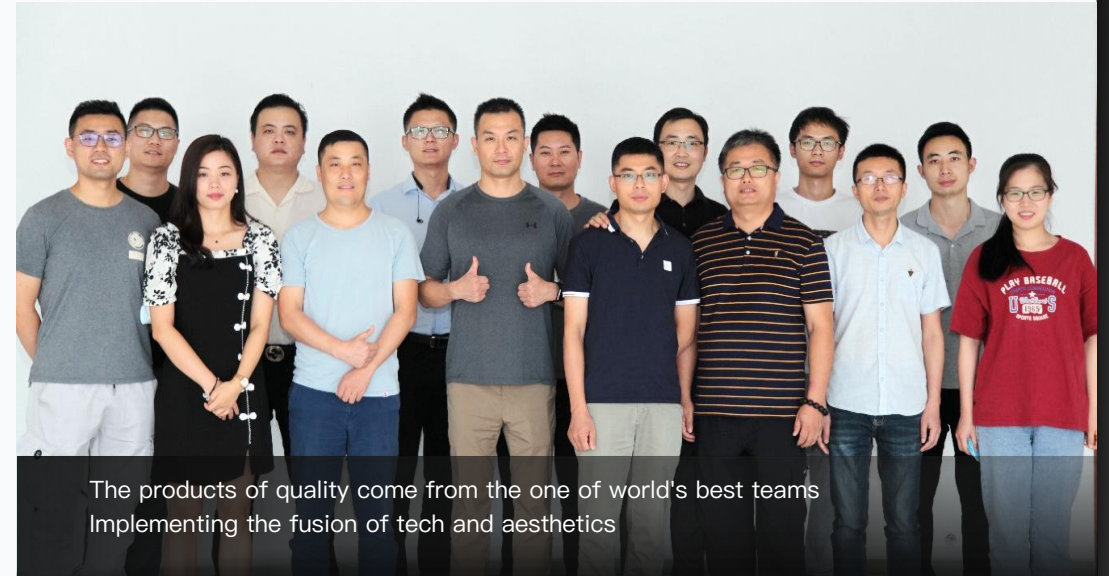

The products of quality come from the one of world's best teams
Implementing the fusion of tech and aesthetics



Redroad gathers 50 engineers and industrial designers who have 20 years of experience in the vacuum cleaner industry in average. They make a full industry chain of talents who are specialized in industrial design, technology research and development, supply chain, manufacturing, quality control, marketing, etc. In close and efficient cooperation, they continue to deliver innovative quality appliances.

Industry Design

Superb design, award-winning

The Redroad team has won multiple global industrial design awards.



reddot



MUSE
DESIGN
AWARDS

It has won industrial design awards including IDEA (International Design Excellence Awards), CMF DESIGN AWARD (CMF DESIGN AWARD), iF Design Award (Germany), Red Dot Award (Germany), G-Mark Award (Japan), etc.



Redroad Brand

Business partners

Shark, Hoover, Dirt Devil, Vax, Eureka, DeLonghi, miele, etc.

Shark



Dirt Devil



EUREKA



Miele

Patented Technologies

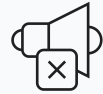

World leading noise reduction technologies Vacuum with pleasure

The company has 47 patents, including 6 invention patents, 21 utility patents, and 20 appearance patents.

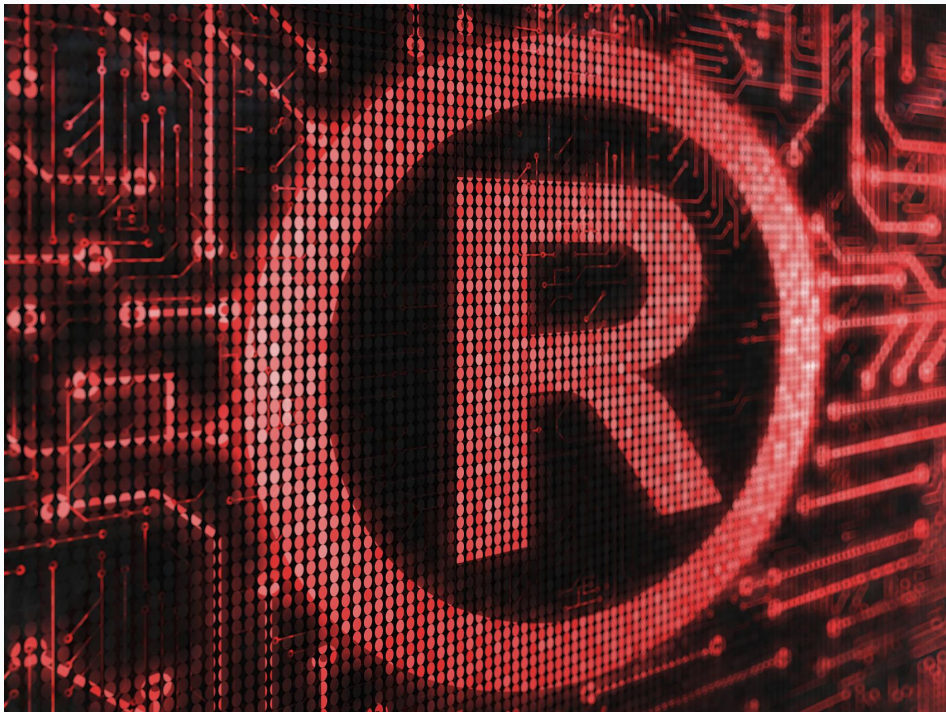

- Mantolo Noise Reduction System 5.0
- **9-stage noise reduction, down to 60dB**
- Removing frequencies of piercing noise with pitch tuning technologies
- Making vacuuming pleasant by minimizing noise pollution

Quality Production

Multiple levels of testing and quality control Making sure of quality production

Redroad improves product quality through strict quality control. It has a quality management team overlooking more than 200 suppliers. The team is professionally competent. And the standards are way higher than the others.



Quality Production

Comprehensive quality testing center

The Redroad quality testing center was built with millions of dollars. It received top global certifications. It has world-class management and testing capability. The testing results are recognized in more than 20 countries and regions.



Testing programs:
noise level, waterproof level, bending capacity of each part service life, etc.
Each process is controlled by strict standards.

Product Matrix

Broadness

It is one of the few professional manufacturers with a full matrix of cleaning products

Greatness

In terms of product performance and configuration, Redroad pursues the best experience with each single product. In terms of specific products, it has gained an comprehensive or partial edge.

Expertise

Redroad has quality workmanship in the pursuit of excellence. The details are reflecting a the strict production, fine quality, and exquisiteness

Depth

Through each exquisite product, Redroad creates the best application. And through the full product matrix, users can take any product they need to achieve true deep cleaning.

robot vacuum

cordless vacuum

wet and dry vacuum

parts and accessories

Redroad is dedicated to making cleaning products with both technological and aesthetic attributes, covering products such as cordless handheld vacuum cleaners, intelligent robot vacuums, and wet and dry vacuums.



02

Products Introduction

Redroad

Product Introduction



Model: V17

cordless vaccum cleaner



Model: V17 Lite

cordless vaccum cleaner



Model: V17 Max

cordless vaccum cleaner



Model: X17

cordless vaccum cleaner



Model: DW1

floor Washer Kit

Redroad

Product Introduction



Model: R7

Auto-empty Vacuum Cleaner



Model: G10

Robot Vacuum and Mop Cleaner



Model: G17

Robot Vacuum and Mop Cleaner



Model: CUT1000

Outdoor Lawn Mower



Redroad V17

Cordless Vacuum Cleaner

450W

Power Rate

26500Pa

Vacuum Suction force

155AW

Suction Power

4000mAh

Battery Capacity

60dB

Noise

Space 3.0

Brushless Motor

60min

Ultra-long Life span

12 Cone

Super Long Life

Product Parameters

Model	V17
Power Rate	450W
Battery Capacity	4000mAh
Suction Power	155AW
Suction Pressure	26.5Kpa
Noise	60dB
Rumtime	60min
Charging Time	4H
Motor Model	Space3.0 Brushless Motor
Dust Cup Capacity	0.6L
Weight	1.62Kg





Redroad V17 Lite

Cordless Vacuum Cleaner

450W

Power Rate

26500Pa

Vacuum Suction force

155AW

Suction Power

4000mAh

Battery Capacity

60dB

Noise

Space3.0

Brushless Motor

60min

Long Life Span

12 Cone

Cyclone Filtration System



Parts & Accessories



Crevice Nozzle



LCD screen

Product Parameter

Model	V17 Lite
Power Rate	450W
Battery Capacity	4000mAh
Suction Power	155AW
Suction Pressure	26.5Kpa
Noise	60dB
Rumtime	60min
Charging Time	4H
Motor Model	Space3.0 Brushless Motor
Dust Cup Capacity	0.6L
Weight	1.62Kg





Redroad V17 Max

Cordless Vacuum Cleaner

450W
Power Rate

26500Pa
Vacuum Suction
Force

4H
Charging Time

4000mAh
Battery Capacity

60dB
Noise

60min
Super Long Life

Space3.0
Brushless Motor

400ml
Dust Bag Capacity



Double roller electric floor
brush for efficient cleaning



LCD color screen
Support 13 languages



Disposable dust bag
No dirty hands throughout the process

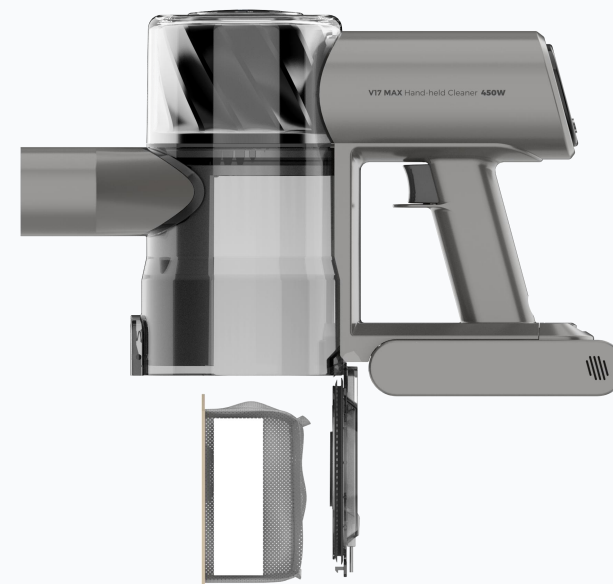

Accessory Diagram

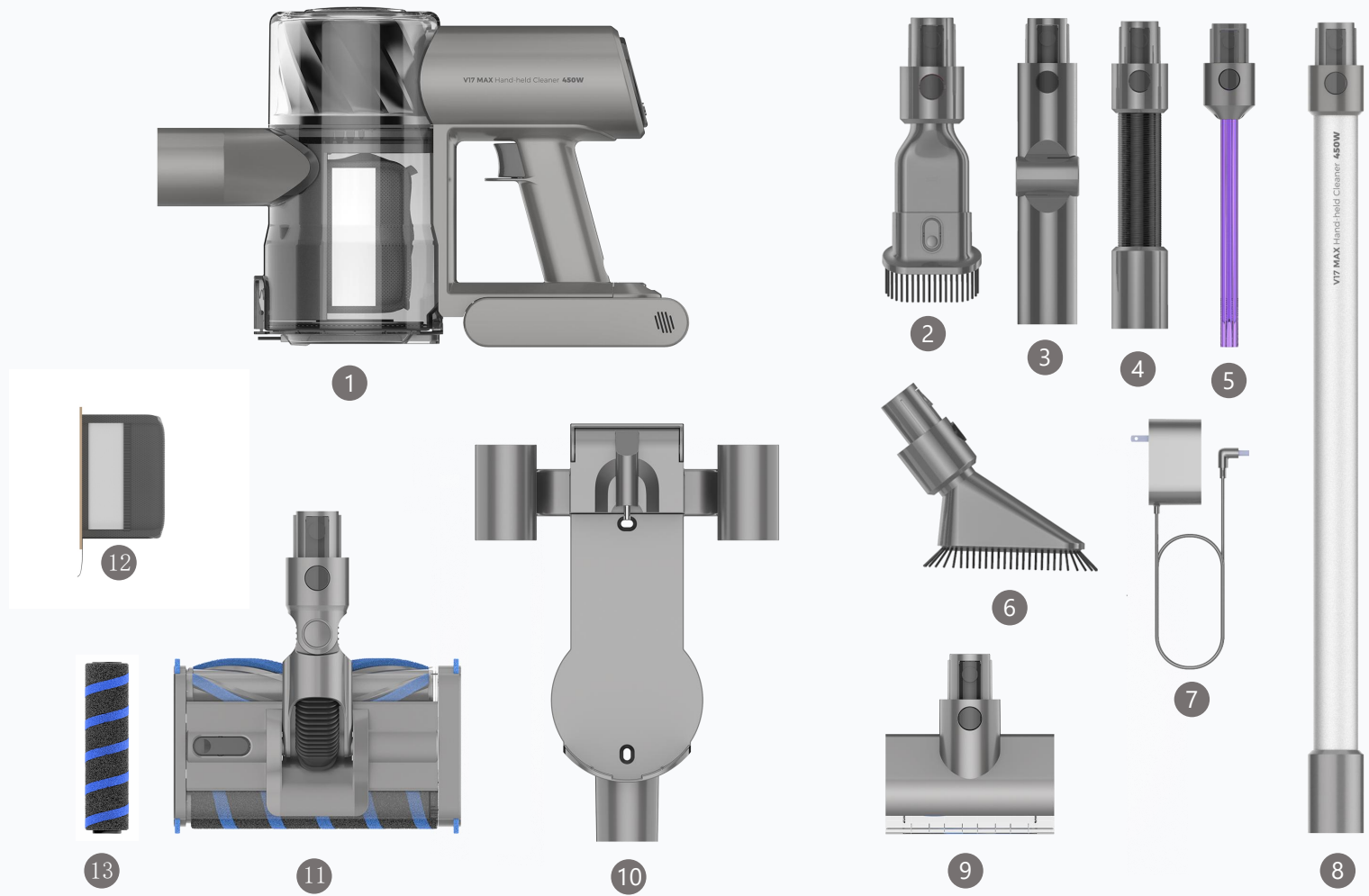

- ① Host
- ② 2-in-1 dusting brush
- ③ Bend
- ④ Telescopic hose
- ⑤ Luminous flat suction
- ⑥ Dusting soft brushes
- ⑦ Adapter
- ⑧ Metal rods
- ⑨ Mite removal brush
- ⑩ Charging storage rack
- ⑪ Electric floor brush
- ⑫ Dust bag*4
- ⑬ Lint roller brush

Product Parameters

Model	V17 Max
Power Rate	450W
Battery Capacity	4000mAh
Suction Pressure	26.5Kpa
Noise	60dB
Runtime	60min
Charging time	4H
Rated Speed	120000rpm
Dust Bag Capacity	0.4L
Rated Voltage	21.6VDC





Redroad X17

Cordless Vacuum Cleaner

350W

Whole machine power

2000mAh

Battery capacity

25000pa

Vacuum suction power

70dB

Noise

600ml

Dust cup capacity

60min

Ultra-long life span



Intelligent sensing of the amount of micro-dust
The more dust, the stronger the suction power



LED screen power level tips
Red, purple and blue power light effect

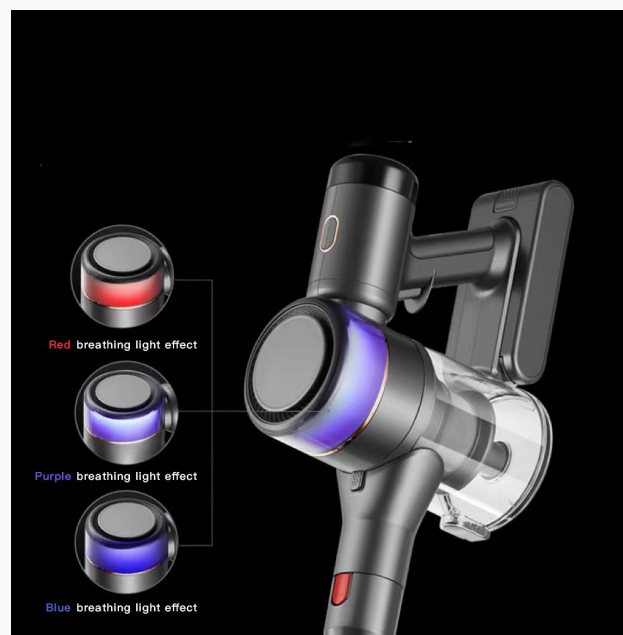

25000pa strong suction power

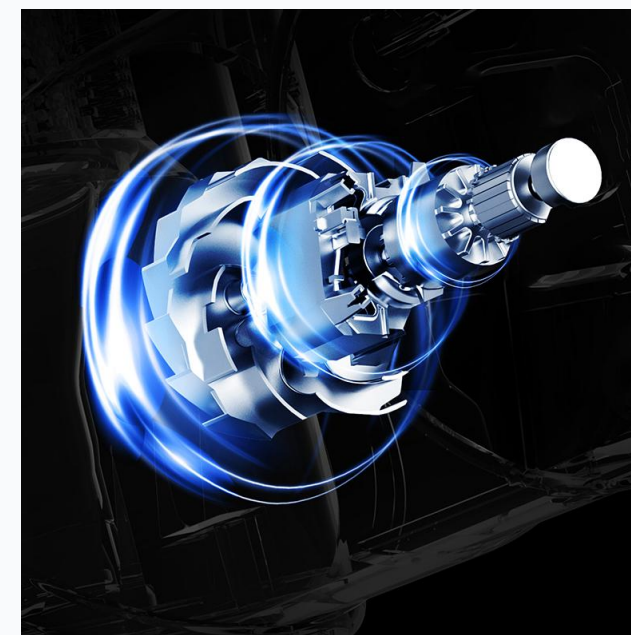

Multi-noise reduction direct airflow

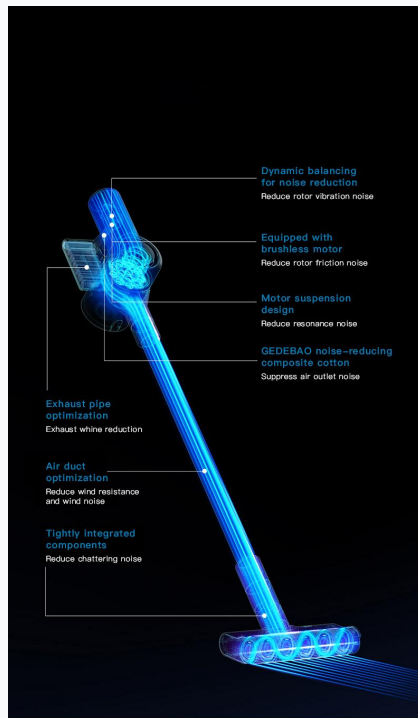

Equipped with independent motor
Deep into the floor crevices

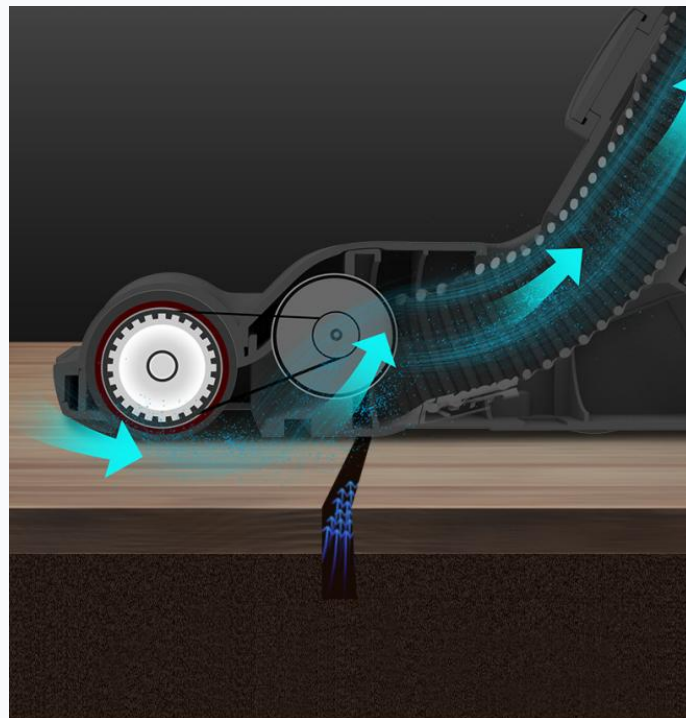

Electric soft velvet roller earth brush



Accessory Diagram



- ① Metal dust pipe
- ② Soft velvet rotating floor brush
- ③ Flat suction nozzle
- ④ 2-in-1 wide mouth brush
- ⑤ Power adapter
- ⑥ Wall bracket
- ⑦ Host
- ⑧ Battery
- ⑨ Electric mite brush

Product Parameters

Model	X17
Power	350W
Battery Capacity	2000mAh
Suction Power	25kpa
Dust Cup Capacity	600ml
Rated Voltage	25.9V
Endurance Time	60min
Noise	70dB
Charging Time	4H





DW1

Floor washer kit
* Accessories

450W
Whole Machine
Power

35W
Rated Power

21.6V
Rated Voltage

1800rpm
Rolling Brush
Speed

500ml
Clear Water Tank
Capacity

400ml
Sewage Tank Capacity

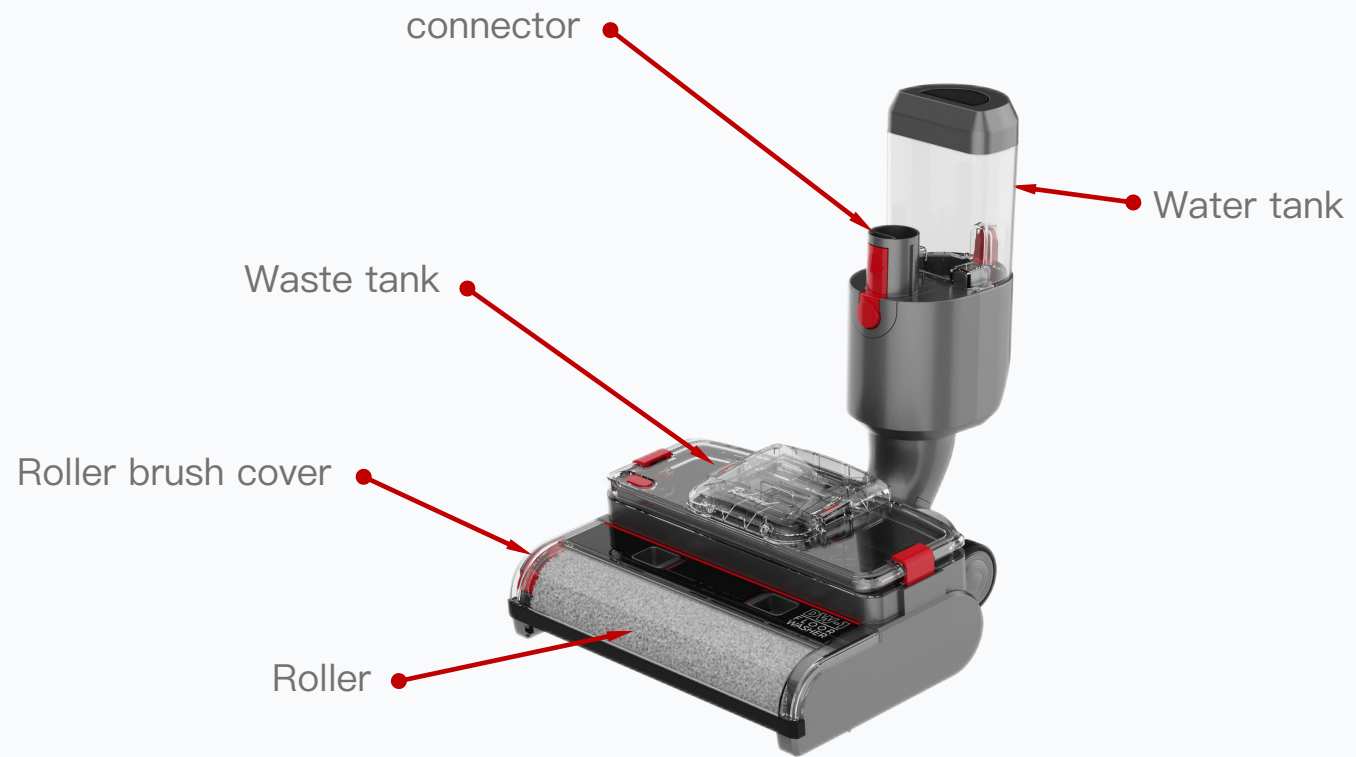

Redroad

Pull to remove the waste tank
Easy to empty and clean



Quick cover removal
Easy to clean



Product Parameters

Model	DW1
Type	Vacuum and mop
Roller Brush	Water-absorbent lint roller brush
Roller Brush Speed	1800 ±10%rpm
Rated Power	450W
Voltage	21.6V
Clear Water Tank Capacity	500ml
Waste Tank Capacity	400ml
No-load Current	1.5A
Load Current	2A





Redroad R7

Auto-empty Robot Vacuum

5200mAh
Battery Capacity

2700Pa
Hurricane Suction
Power

65dB
Noise

300ml
Dust box Capacity

250ml
Water Tank Capacity

170min
Water Tank Capacity

Redroad



3DToF Along the wall cleaning



Screen for easy user interaction



5200mAh-LG battery



170min long runtime



2700pa vacuum

2700 pa



Product Parameters

Model	R7
Vacuum	Boost 2700pa Medium 1800pa Standard 1200pa Eco 700pa
Battery Capacity	5200mAh
Motor	Brushless-Nidec
Along the Wall Cleaning Tech	3DTOF
Dust tray capacity	300ml
Water Tank Capacity	250ml
Runtime	Standard (170min) Up to 250min
Noise (Standard)	< 65dB
User Interaction	Screen/APP
Dimensions	350*350*98mm





Redroad G10

Robot Vacuum

5200mAh

Battery Capacity

2800Pa

Hurricane Suction
Power

72dB

Noise

450ml

Dust Box Capacity

450ml

Water Tank Capacity

170min

Super Long Life

Redroad



Vibrating mopping



Electrolytic water sterilization

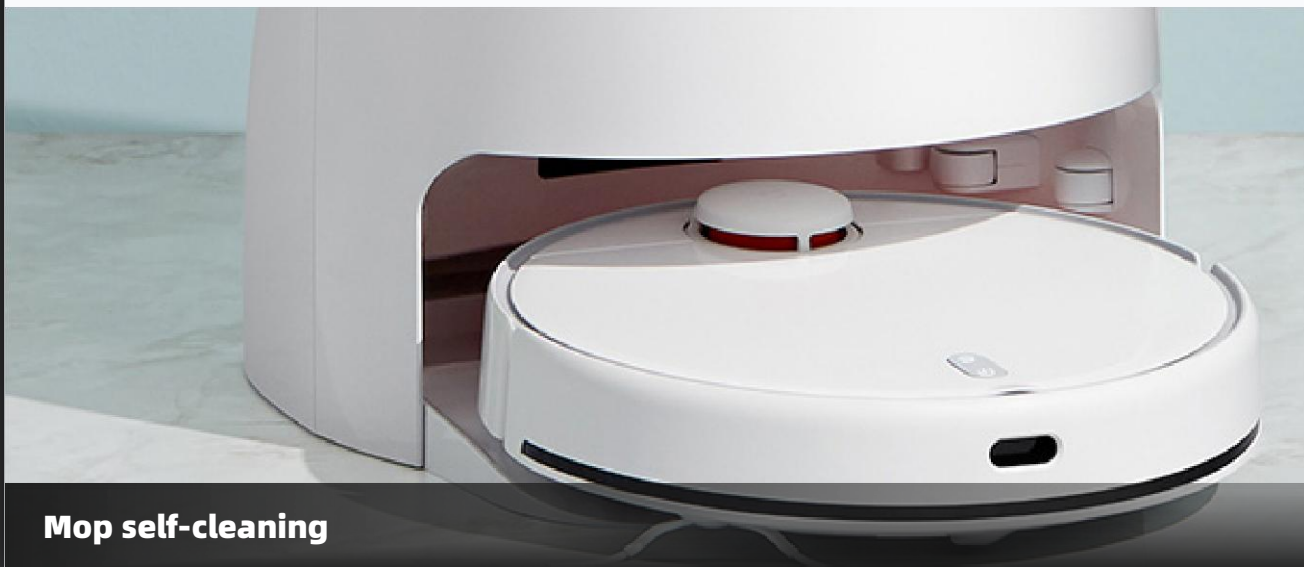

Mop self-cleaning

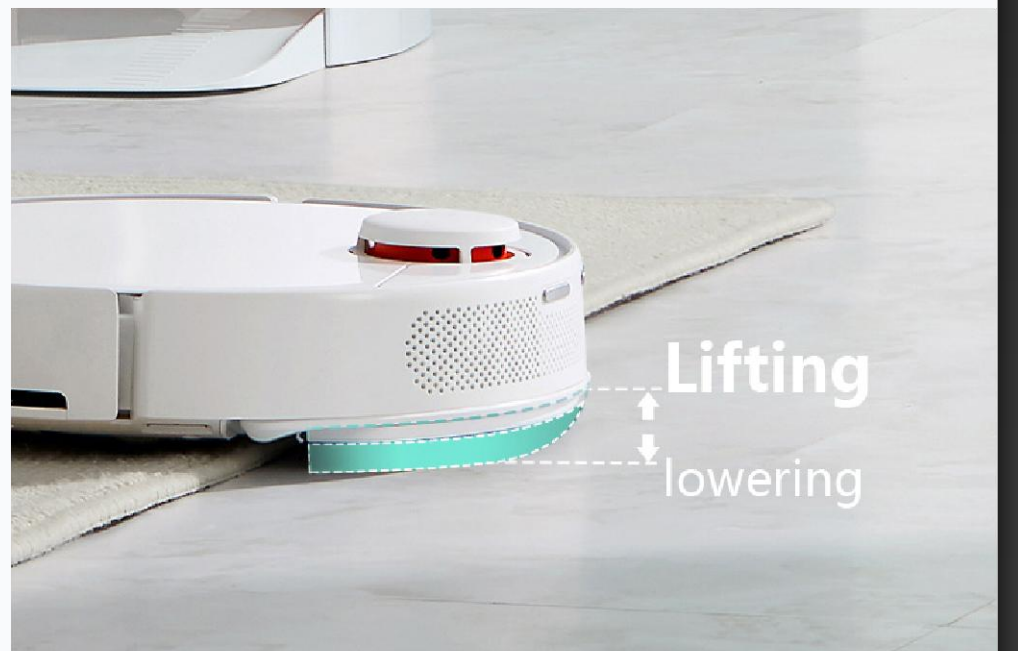

Carpet detection, mop lifting

Product Parameters

Model	G10
Vacuum	Boost 2800pa Medium 2000pa Standard 1000pa Eco 600pa
Battery Capacity	5200mAh
Motor	Brushless motor-Nidec
Along the Wall Cleaning Tech	3DToF
Dust tray capacity	450ml
Water Tank Capacity	4.5L
Runtime	Standard (170min) Up to 240min
Noise (Standard)	< 72dB
User Interaction	APP
Dimensions	353*353*96.5





Redroad G17

Sweeper

4000pa
Hurricane Suction
Power

3200mAh
Battery

64dB
Noise

480ml
Dustbin capacity

250ml
Clear water tank
capacity

250ml
Sewage tank capacity

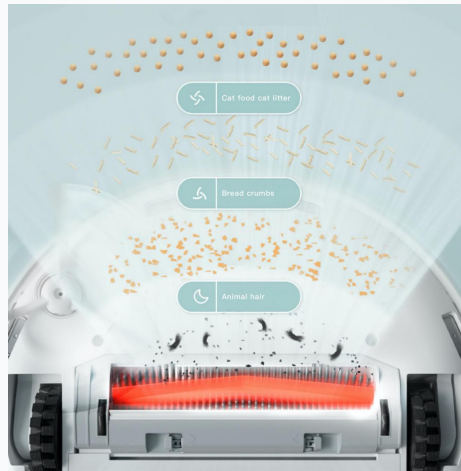

4000Pa high suction power

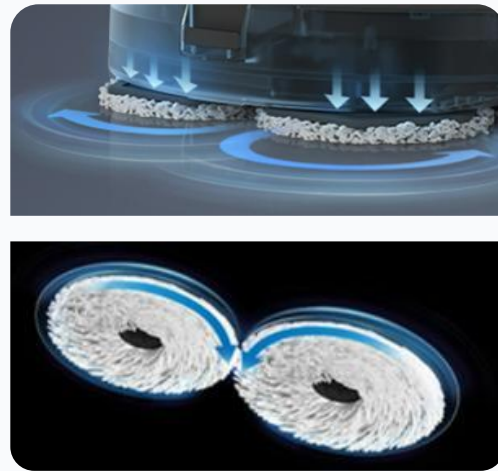

Rotating mopping floor



Automatic mop washing

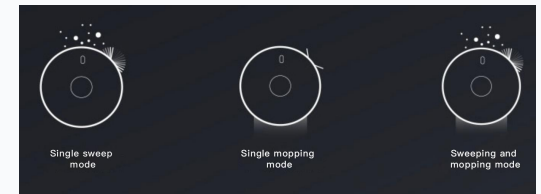

Three models

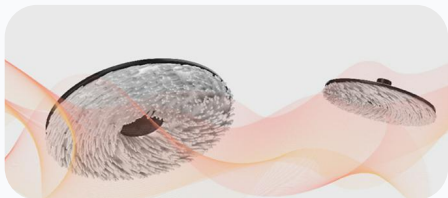

PTC hot-air drying

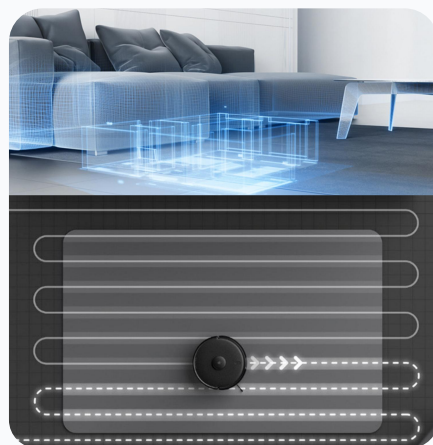

LDS Laser Navigation



**Ultra-strong
barrier crossing**



**Appointment
Cleaning**

Product Parameters

Model	G17
Suction Power	4000pa/2000pa/1000pa/600pa
Battery Capacity	3200mAh
Dust Collection Suction Power	17000pa
Navigation System	LDS Radar
Dustbin Capacity	480ml
Clear Water Tank Capacity	250ml
Sewage Tank Capacity	250ml
Noise (Standard gear)	< 64dB
Barrier Crossing	Single-wheel 20mm





Redroad CUT1000

Lawn mower

25cm
Cutting Width

5.0Ah
Battery Capacity

57dB
Noise

100min
Charging Time

1000m²
Cleaning Range

110min
Ultra-long Life Span

Redroad

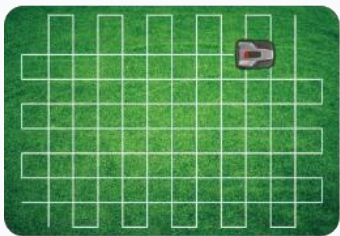
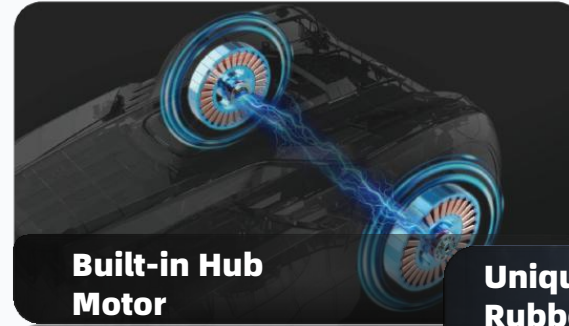
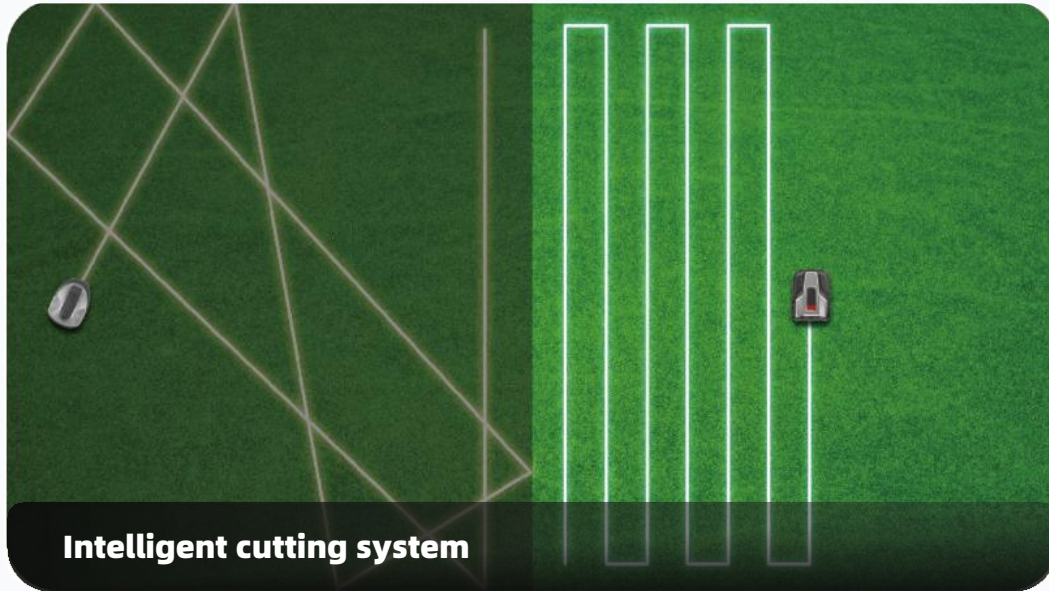

Product Parameters

Model	CUT1000
Working Area Capacity	1000m ²
Area Capacity Per Hour	157m ²
Max.slope	45%
Cutting Height	30-60mm(40-80mm@U.S.)
Cutting Width	25cm
Cutting Disc	4 picoting razor blades
Lithium-ion Battery Capacity	5.0Ah
Charge Time/Run Time	100min/110min
Motor Type	Hub Motor
Noise	57dB
Protection Index	IPX5
Dimensions	628*461*248mm
Weight	14kg





03

Products Comparison



Redroad V17
Cordless Vacuum Cleaner
21.6VDC
155AW
450W
3 types
26.5Kpa
60dB
6
4000mAh
60min
4H
√
12 Cone
12K
0.6L
LCD Cscreen
√
1.62Kg
Electric mite brush, luminous flat suction, 2-in-1 dusting brush, extended hose, bent hose, triangle brush
1. Double-rolling electric floor brush, efficient cleaning stains, anti-tangle 2. Five-fold filtration system, inlet and outlet equipped with dual HEPA filter, as small as 0.1 microns from the dust efficiency of up to 99.97% 3. Noise reduction technology, as low as 60db 4. LCD color screen, display power, machine status, supplies replacement reminder, fault alarm

Product Model
Product Type
Rated Voltage
Suction Power
Power of the Whole Machine
Suction Mode
Vacuum Degree
Noise
Number of Electric Cells
Battery Capacity
Endurance Time
Charging Time
Battery Removable
Cyclone Filtration
Motor Speed
Dust Cup Capacity
Intelligent Display Screen
Charging Storage Rack
Weight of Main Unit
Other Accessories
Main Selling Point

Dreame V11 SE
Cordless Vacuum Cleaner
25.2V
150AW
450W
/
24Kpa
86dB
7
2500mAh
60min
3.5H
×
12 Cone
12.5K
0.5L
LED touch screen
√
1.6Kg
Electric mite brush, 2-in-1 flat suction, 2-in-1 brush, extension hose
1.125,000rpm high speed engine 150AW powerful suction power 2.LED high-definition touch screen, intelligent interaction 3. V-shaped full brush to prevent hair tangling 4.12 cone cyclone separator, achieve 99.6% ultra-high dust air separation efficiency





Redroad V17 Lite	Product Model	Dreame XR
Cordless Vacuum Cleaner	Product Type	Cordless Vacuum Cleaner
21.6VDC	Rated Voltage	25.2V
155AW	Suction Power	140AW
450W	Power of the Whole Machine	450W
3 Types	Suction Mode	3 Types
26.5Kpa	Vacuum Degree	22Kpa
60dB	Noise	67dB
6	Number of Electric Cells	7
4000mAh	Battery Capacity	2500mAh
60min	Endurance Time	60min
4H	Charging Time	3.5H
√	Battery Removable	×
12Cone	Cyclone Filtration	8Cone
12K	Motor Speed	10K
0.6L	Dust Cup Capacity	0.5L
LCD Screen	Intelligent Display Screen	×
×	Charging Storage Rack	√
×	Retractable Tube	×
Luminous Flat Suction	Other Accessories	2-in-1 dusting brush, flat brush, extension hose
1.62kg	Weight of Main Unit	1.5kg
1. Double-rolling electric floor brush, efficient cleaning stains, anti-tangle 2. Five-fold filtration system, inlet and outlet equipped with dual HEPA filter, as small as 0.1 microns from the dust efficiency of up to 99.97% 3. Noise reduction technology, as low as 60db 4. LCD color screen, display power, machine status, supplies replacement reminders, fault alarm	Main Selling Point	1. Five filtration system - 0.3 micron dust filter - 99.99% particle retention 2. Strong suction power (22Kpa wind pressure, 140AW suction power) 3. 60 minutes endurance time 4. Double spiral carpet brush with independent motor provides stronger suction power

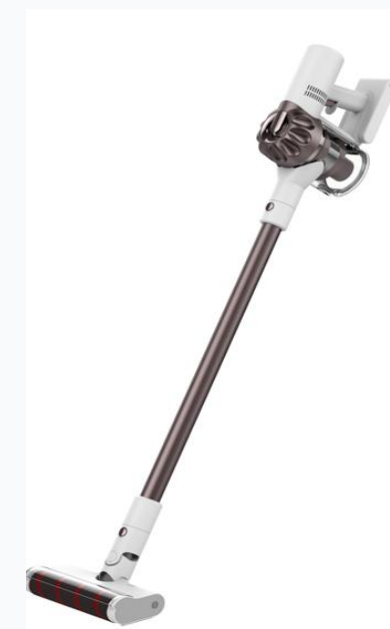

Redroad



Redoad V17 Max
Cordless Vacuum Cleaner
21.6VDC
450W
3 Types
26.5Kpa
60dB
6
4000mAh
60min
4H
√
120000rpm
0.4L
√
√
×
2-in-1 dusting brush, elbow, telescopic hose, luminous flat suction, dusting soft brushes, dusting brush, charging storage rack

Product Type
Product Type
Rated Voltage
Power of the Whole Machine
Suction Mode
Vacuum Degree
Noise
Number of Electric Cells
Battery Capacity
Endurance Time
Charging Time
Battery Removable
Motor Speed
Dust Cup Capacity
Intelligent Display Screen
Charging Storage Rack
Retractable Tube
Other Accessories

Dreame V11
Cordless Vacuum Cleaner
25.2V
450W
3 Types
25Kpa
65dB
7
3000mAh
90min
×
125000rpm
0.5L
√
√
×
2-in-1 multifunctional nozzle, 2-in-1 flat nozzle, mite removal brush, telescopic hose, charging storage rack





04

Brand Promotion

Channels — Online channel structure

The company has applied for 47 technical patents, including 6 invention patents, 21 utility model patents and 20 appearance patents.

Traditional
e-commerce platforms



Boutique and social media
e-commerce platforms



小米有品



全世界的好东西





Channels — Offline channel structure

We have covered major e-commerce platforms, social e-commerce, self-media e-commerce and bank point malls, etc.

Redroad began a major expansion of its offline channels in 2020.

Currently, it has presence in more than 100 large supermarkets, cell phone digital stores, home furnishing retail stores, and trendy fashion stores.



Global Reach



 Vector world map



Brand Marketing

Celebrated by a wide range of media channels

French media

Redroad V17
aspirateur à main silencieux sans fil

Redroad V17 : un nouvel aspirateur balai sans fil silencieux avec une autonomie de 60 minutes

Redroad: noise-free stick vacuum Lesalexien

Italian media

REDROAD VEDE LA QUALITÀ DEL PRODOTTO COME UN'ANCORA DI SALVEZZA

RedRoad ed il controllo di qualità: tutti i passaggi ed i test dell'azienda

Redroad and quality control: all the processes and tests

German media

TEST REPORT: REDROAD V17 CORDLESS VACUUM CLEANER WITH DOUBLE ROLLER BRUSH

Review: Redroad V17 cordless vacuum cleaner with double roller brush

Review: Redroad V17 cordless vacuum cleaner with double roller brush

British media

Redroad Quality Production

Redroad V17

Redroad quality production

Russian media

Мебель на заказ из дерева!

Redroad V17. Пылесос будущего

Redroad V17, vacuum cleaner of the future online24news

Russian media

RedRoad V17 – пильный, беспроводной odkurzacz ręczny. Wykonany zgodnie z rygorystycznymi kryteriami produkcji

Redroad V17 cordless stick vacuum cleaner Produced by strict standards

Redroad V17 cordless stick vacuum cleaner Produced by strict standards

Turkish media

Nedir, Nasıl Yapılır

Redroad V17 cordless vacuum cleaner demonstration teknolojidolabi

Redroad V17 cordless vacuum cleaner demonstration teknolojidolabi

American media

RedRoad, Born for your Nice and Neat way of Living

Redroad, born for your comfy and clean living space iTechpost

Redroad, born for your comfy and clean living space iTechpost

Spanish media

ROJANO VE ABOGADOS

Redroad V17: full-house vacuum cleaner for deep cleaning

Redroad V17: full-house vacuum cleaner for deep cleaning



Brand Marketing

Appreciated and recommended by KOLs

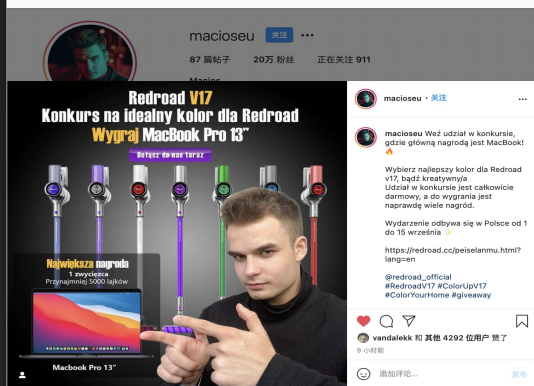

Poland INS

Lifestyl macioseu
208k



German INS

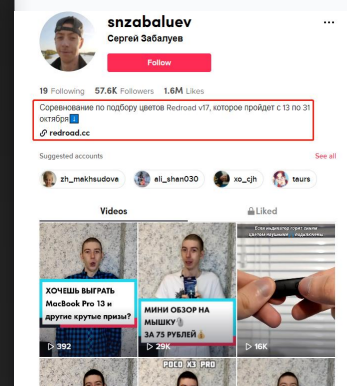

Russia TIKTOK



Turkey INS

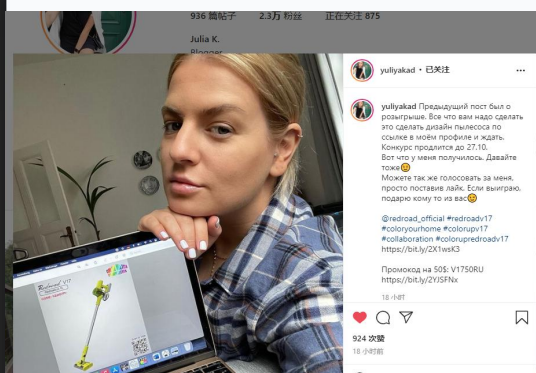

Russia INS

Lifestyle yuliyakad
25.7k

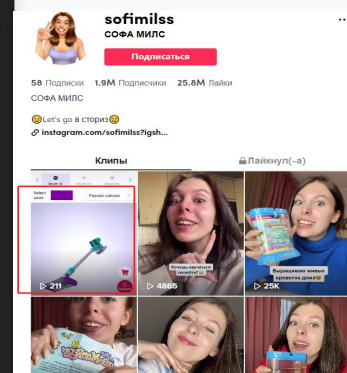

Russia TIKTOK

Tiktok lifestyle sofimilss
190w



Brand Marketing

Core channel KOLs livestream recommendation



#weekinmylife
A WEEK IN MY LIFE, berufsschule, die erste klausur, daily to do's
15,173次观看 · 2021年12月1日

German KOL

Lifestyle
Cara Samstag
12.9k



MES MORNINGS ROUTINE + NOUVELLE ACQUISITION: REDROAD V17
7,702次观看 · 2022年1月11日

France KOL

Lifestyle
Robyn Right 72k



GARIŞIK VLOG 1 Final Notlarım, İstanbul, Arkadaşlar, Bute Kaldım, Redroadv17
37,888次观看 · 2022年2月11日

Turkey KOL

Lifestyle Dersu Pilami 127k



测试Redroad无线吸尘器V17 @ vlog 272
746 / 1548

Poland KOL

Lifestyle YouRi 99.2k



Растакова Тест ДРАЙВ С примеркой / Крутые НОВИНКИ #DolceChris
517,100次观看 · 2022年1月11日

Russia KOL

Lifestyle Dolce Chris 54.7k



Redroad

Thanks for watching!